

JEREMIAS

SOLUCIONES INDUSTRIALES

www.jeremias.com.es



PALAU SANT JORDI
BARCELONA



PALAU SANT JORDI

BARCELONA

- 2 Chimeneas industriales autoportantes FSB ducto interior portante
- Tubo exterior de 25 m de altura y Ø800 realizado en acero inoxidable
- Trabajo completo de demolición de chimeneas existentes y montaje de las nuevas realizado completamente por Jeremias



SIDENOR - SPECIAL STEELS

BASAURI, SPAIN

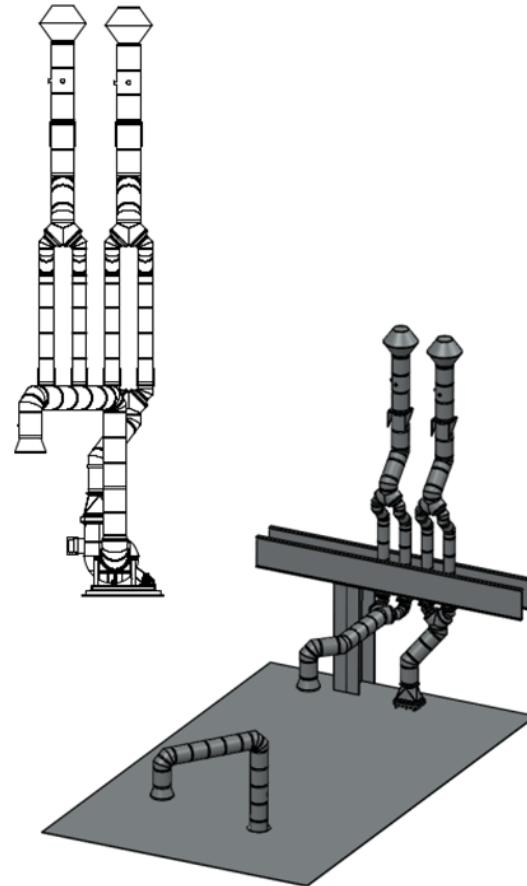
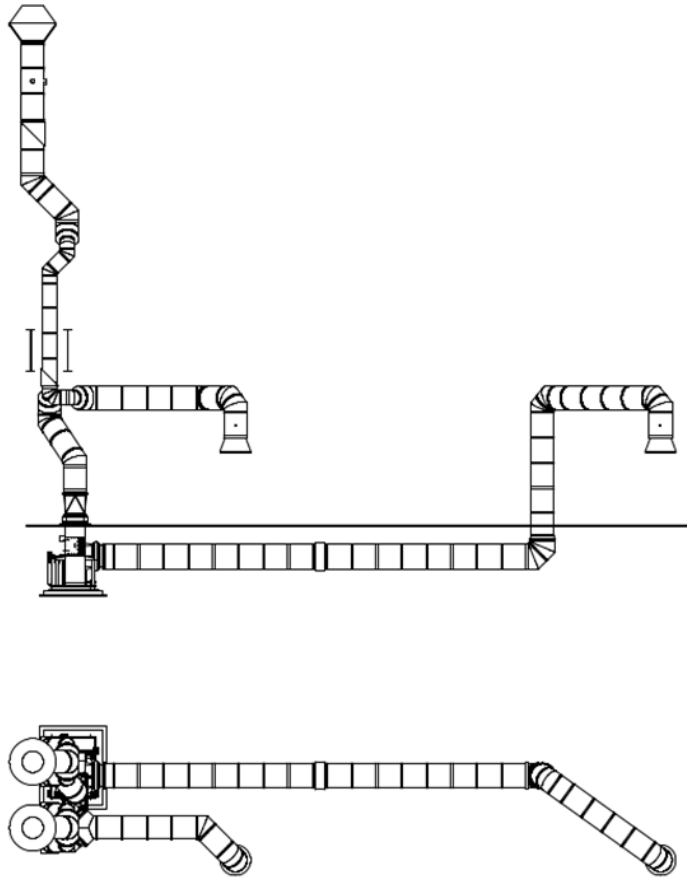

revision	date	name	drawn	date	name	description
0	29/08/2019	Santi López	drawn	17/10/2019	Santi López	
1	11/09/2019	Santi López	checked			
2	24/09/2019	Santi López	drawn			

Jeremias

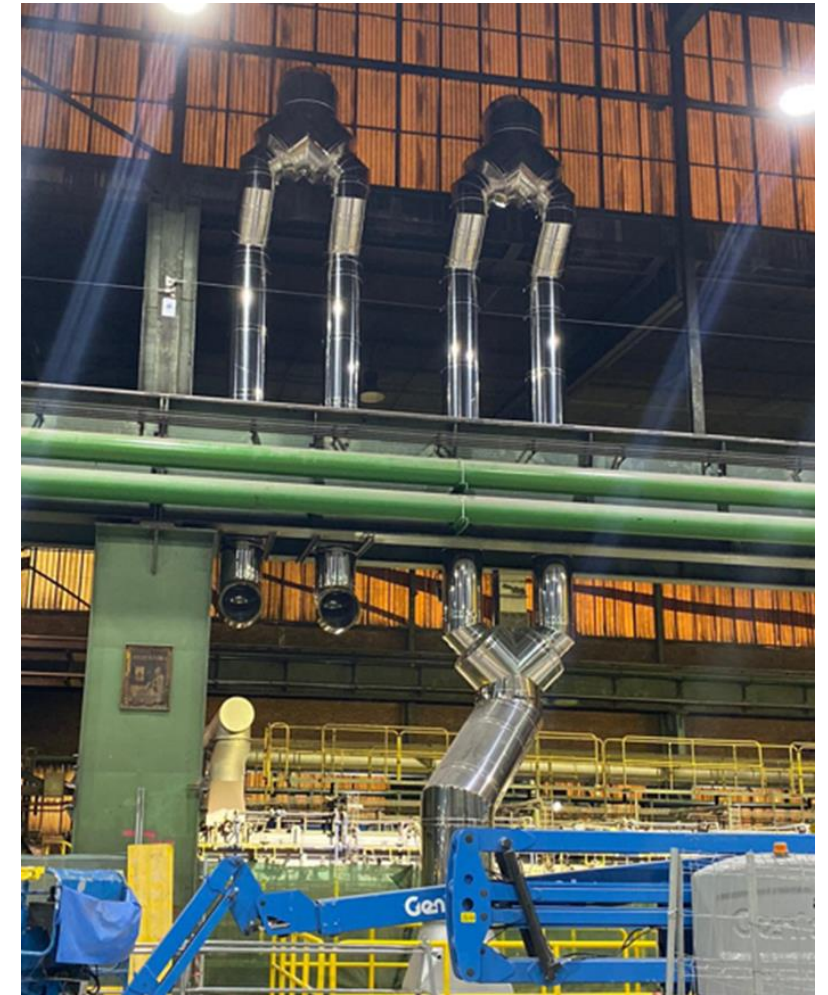

POLIDEPORTIVO BENTABERRI

DONOSTIA / SAN SEBASTIÁN

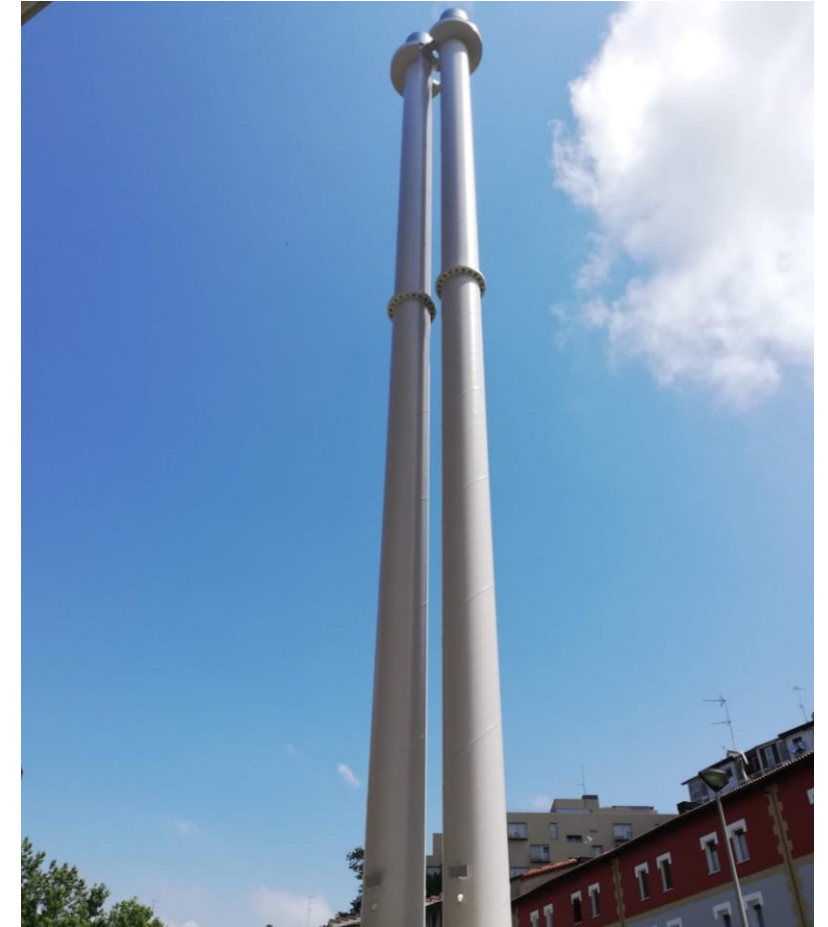

RED DE CALEFACCIÓN URBANA

SOLDEU, ANDORRA

- Chimeneas autoportantes FSA diámetro 500 y 650mm
- Conducto exterior portante de 15m de altura
- Producción y montaje en diferentes fases



CENTRAL TÉRMICA FASA

VALLADOLID

- Combinación de estructura en celosía y conductos modulares
- 2 chimeneas modulares para calderas
- 1 Sistema de escape de grupo electrogeno



RED DE CALEFACCIÓN COMPLEJO EDUCATIVO

PISA, TOSCANA - ITALIA



P-ENERGY

ALMERIA SPAIN

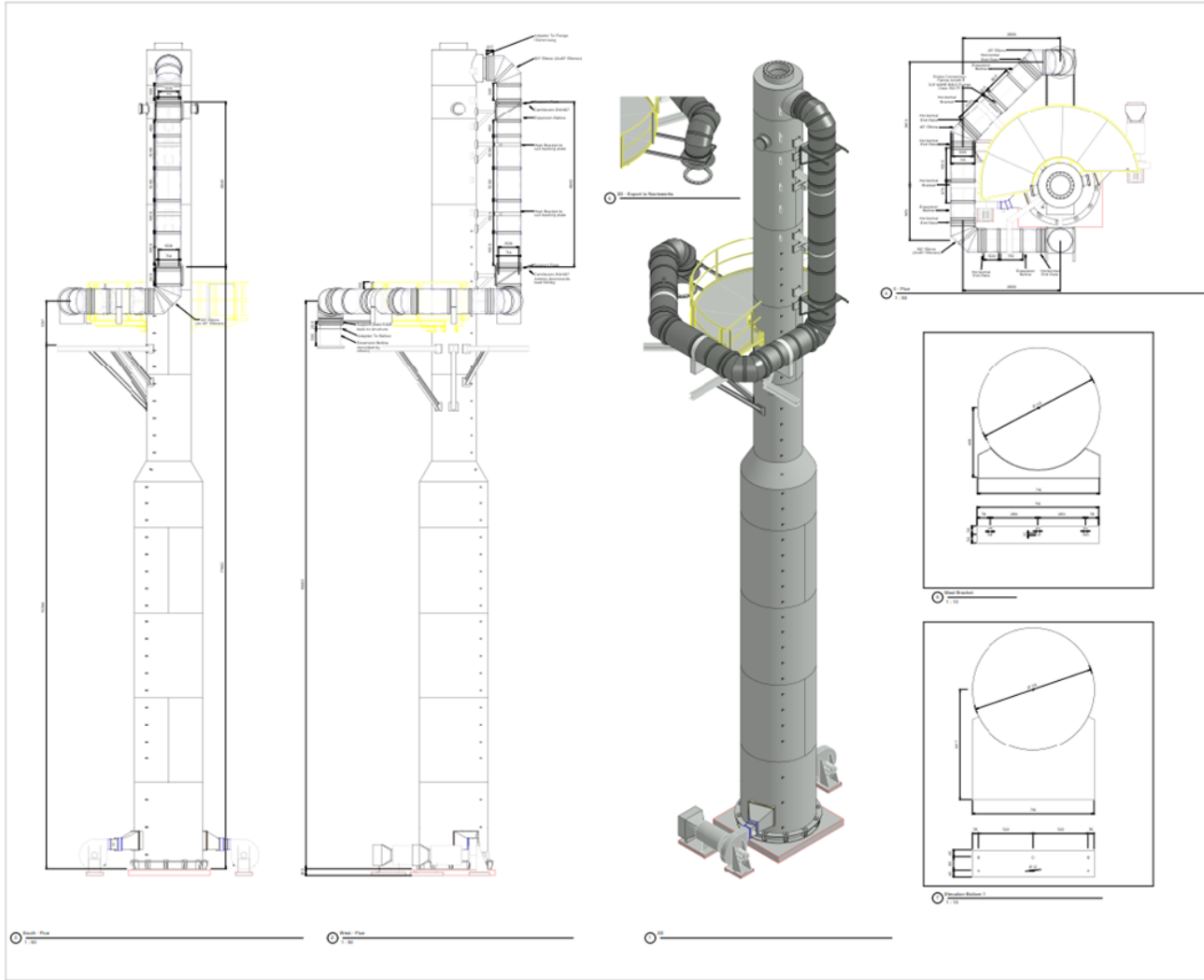

SHOPPING CENTER EL VASCO

OVIEDO, SPAIN

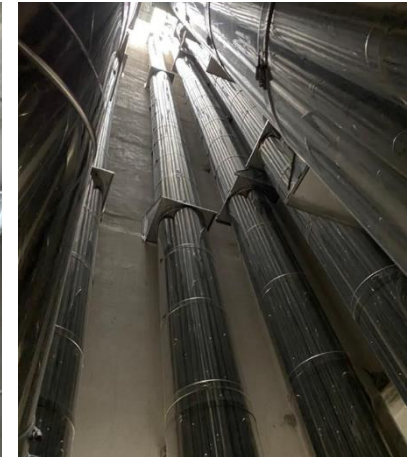
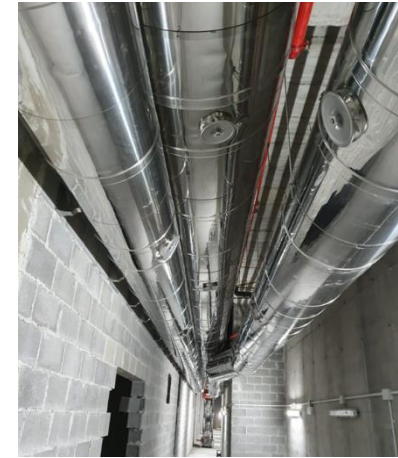
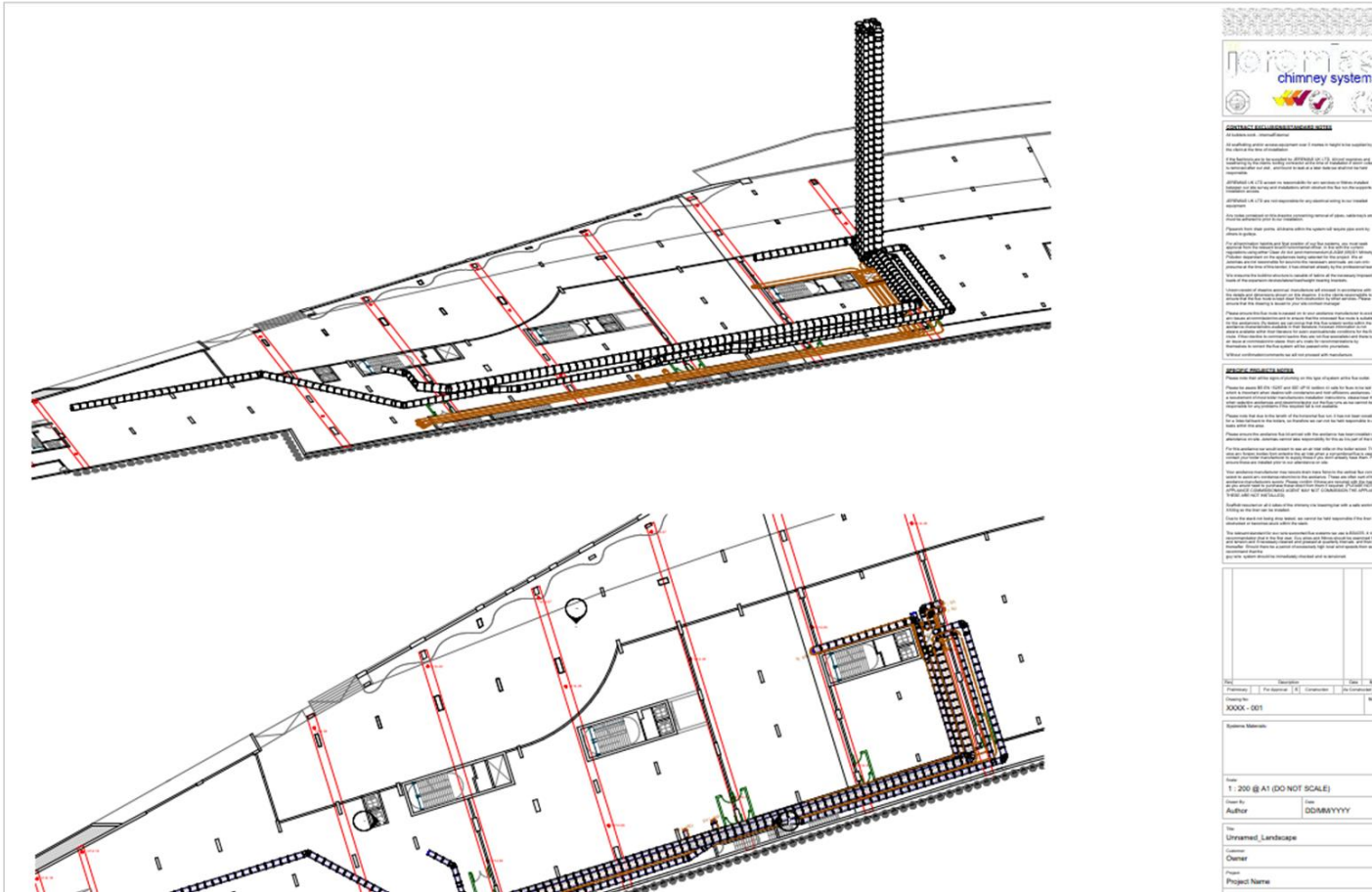

PLANTA BIOMASA BURGOS

VILLALONQUÉJAR, BURGOS

- Chimenea industrial autoportante FSA, Ø800
- Ducto exterior portante de 25 m de altura
- Proyecto industrial que combina trigeneración de energía con biomasa y potencia fotovoltaica



PLANTA TRATAMIENTO DESULFURACIÓN

BURGOS

- Chimenea industrial autoportante de 50m de altura
- Diámetro de 1700mm
- Recubrimiento especial anticorrosión en el interior del conducto
- Desnebulizador a medida para reducir la densidad de los humos

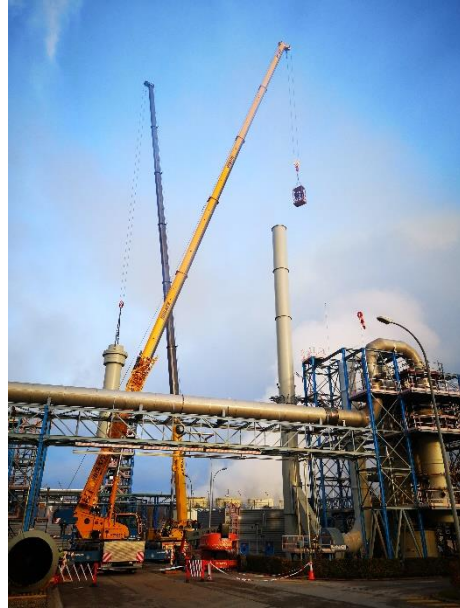

PLÁSTICOS MEXICHEM

TAMAULIPAS, ALTAMIRA, MÉXICO

- 2 chimeneas industriales autoportantes FSA, Ø 1500mm
- Ducto exterior portante de 25 m de altura
- Generación de energía para planta industrial sector químico



CENTRAL HEATING PAMPLONA

NAVARRA, SPAIN



FSC LAMINADO LEÓN

LEÓN, SPAIN

- 2 Chimenea de evacuación simple pared FSC de Ø2115 interior
- Acero inoxidable AISI304, espesor 6mm y 25 m de altura
- Evacuación de vapores de tren de laminación metálica



TRATAMIENTO DE HUMOS

BAYONA, FRANCIA



POSHTEL BILBAO

BILBAO

- Combinación de mástil en celosía y conductos modulares
- 2 conductos modulares para extracción de campanas de cocina con resistencia al fuego EI30
- Solución integral en centro ciudad



PRODUZIONE INDUSTRIAL

SONDRIO, LOMBARDIA, ITALIA



ENERGY CENTER

KERDROUAL, FRANCE



PRODUCCIÓN DE CACAO

TERRASA

- Chimeneas autoportantes FSA diámetro 500
- Conducto exterior portante de 20m de altura
- Montaje completo con plataforma y escalera



INDUSTRIA FARMACEUTICA

MONZA, LOMBARDIA - ITALIA

- Estructura de soportación en celosía
- Dos silenciadores combinados a medida insertados en la vertical del sistema con reducción de 35 DB
- DW KL en diámetro 700mm
- Mas de 80 metros en total

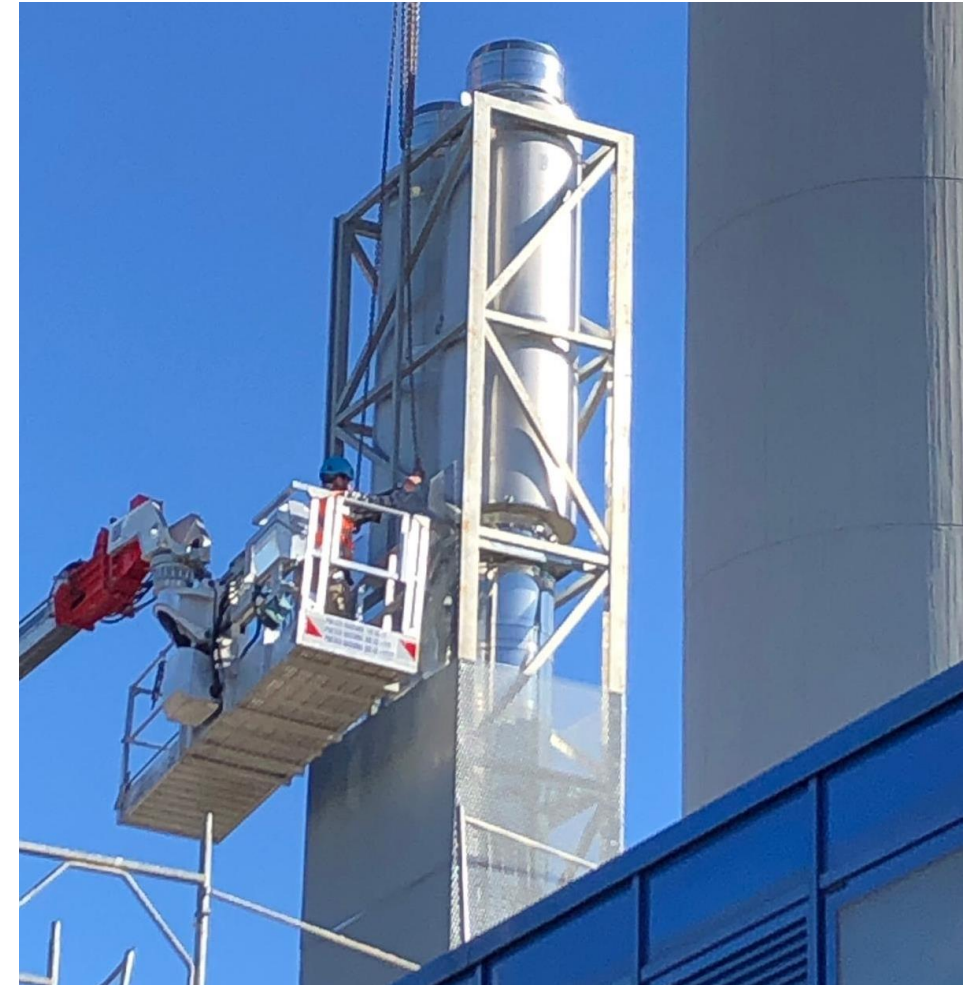

REFINERÍA DE ALUMINIO

LEGUTANIO, ALAVA

- Chimenea industrial autoportante de 22m de altura
- Diámetro de 700mm
- Plataforma de acceso a toma de muestras en 360°



INDUSTRIA FARMACEUTICA

PARMA, EMILIA ROMAGNA, ITALIA

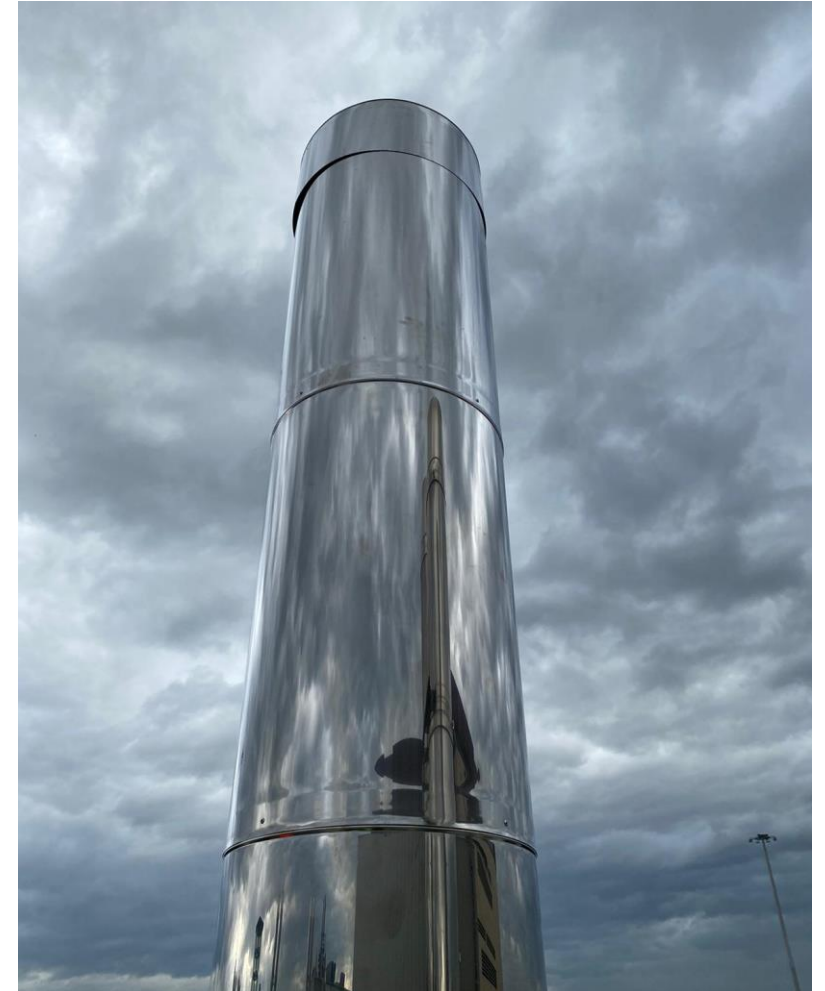

PRODUCCIÓN INDUSTRIAL NEUMÁTICOS

MILANO, LOMBARDIA - ITALIA

- Estructura de suportación en celosía
- Sistema modular
- Cubreaguas especial realizado in-situ
- Conexiones horizontales a medida
- Proyecto «llave en mano»

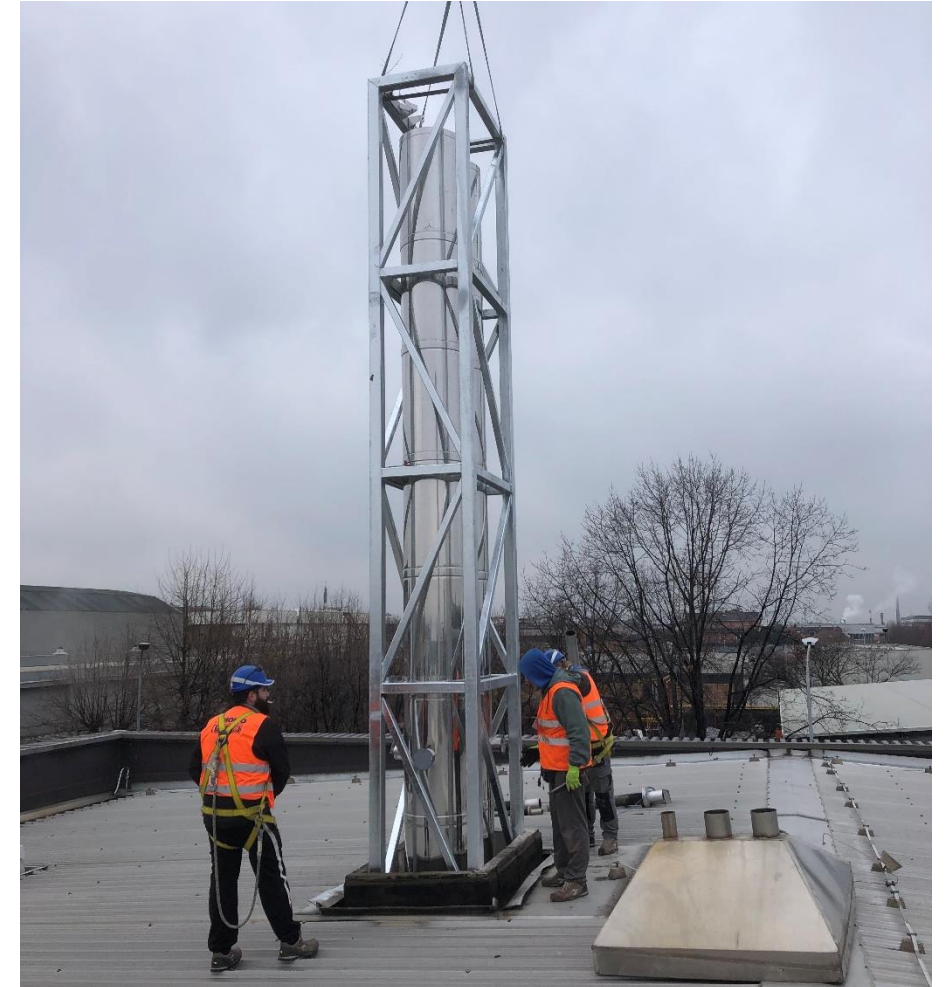

HOTEL SELENZA

MADRID

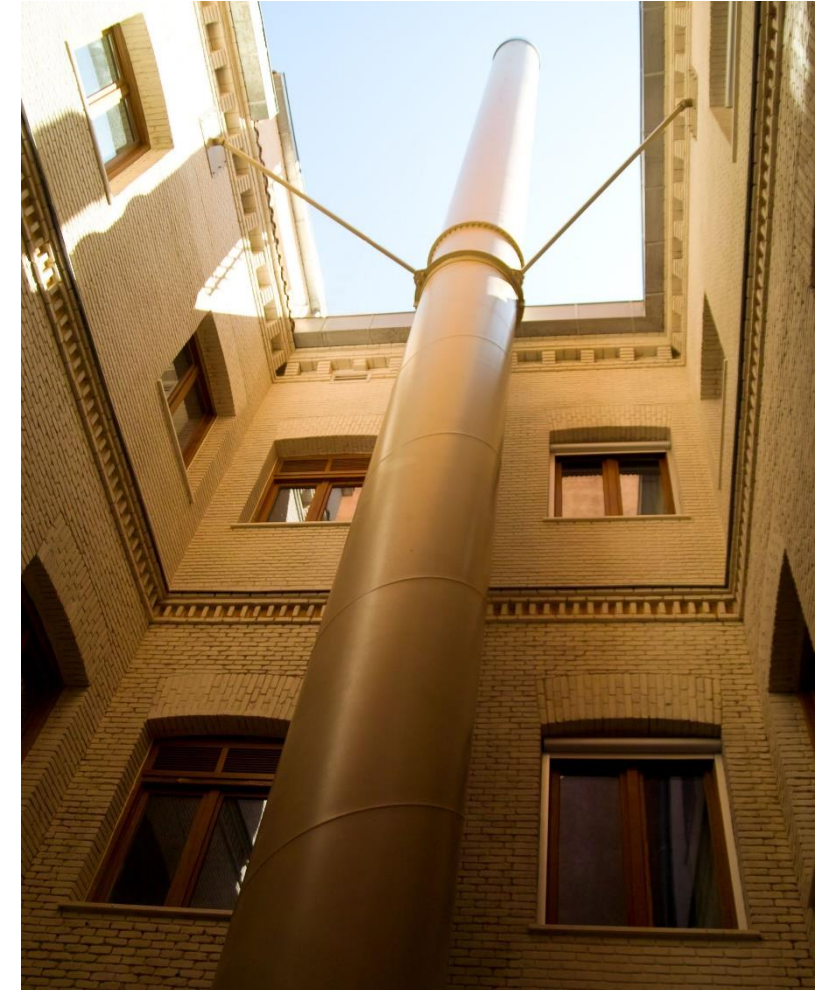

PANADERÍA INDUSTRIAL

FLUMERI (AV), CAMPANIA - ITALIA



LAMINADO DE ACERO

LEÓN, SPAIN



DC AMSTERDAM

NEDERLANDS



EDIFICIO PLANETA

BARCELONA, SPAIN



INDUSTRIAL COFFEE ROASTER

BERLIN, GERMANY



EXTRACION DE CABINAS PINTURA

LE HAVRE, FRANCIA





G.S.
FRANKFURT



OIL & GAS

Balen Belgica

INDUSTRIAL COFFEE ROASTER

TORINO, ITALY

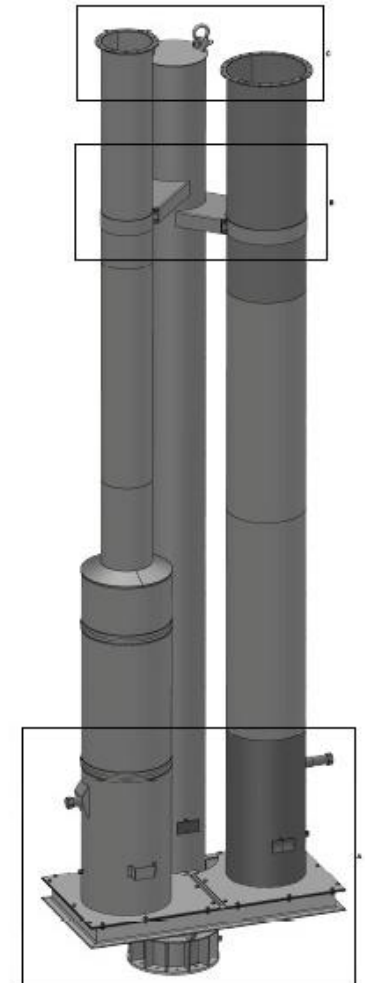

AMS1

Amsterdam

INDUSTRIAL COFFEE ROASTER

MAINASCHAFFT- GERMANY



DC RÜMLANG

SWITZERLAND



INDUSTRIAL COFFEE ROASTER

NORWAY



CALDERA DE BIOMASA

STRASBOURG, FRANCIA



DC FRANKFURT

GERMANY



DC FRANKFURT

GERMANY



INDUSTRIAL COFFEE ROASTER

PANAMA CITY, PANAMA

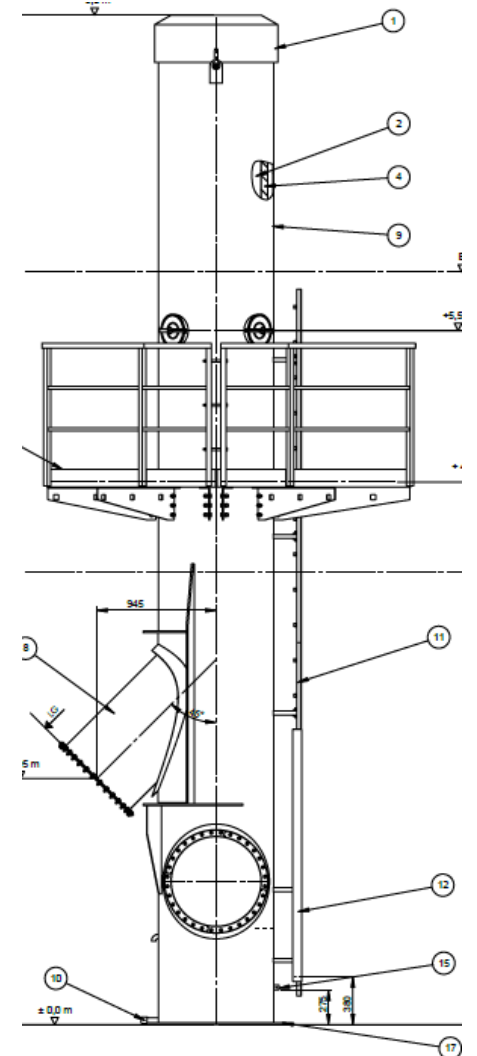

RED DE CALEFACCIÓN URBANA

ANDORRA



INDUSTRIAL COFFEE ROASTER

ZAANDAM, NEDERLAND



VANTAGE DC

BERLIN, GERMANY

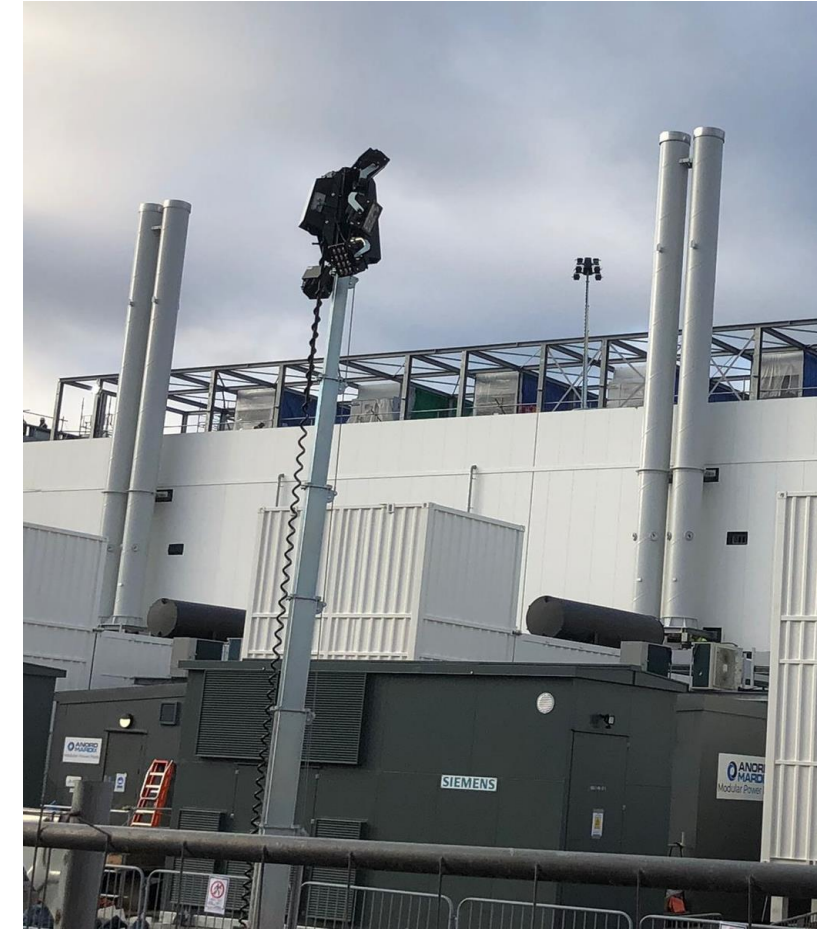

RED DE CALEFACCION URBANA BIOMASA

TRESTEL FRANCIA



GEOOTHERMIA

UNTERFÖHRING, GERMANY



FOOD INDUSTRY

BLUMBERG, GERMANY



BMW - AUTOMOCION

DINGOLFING, GERMANY

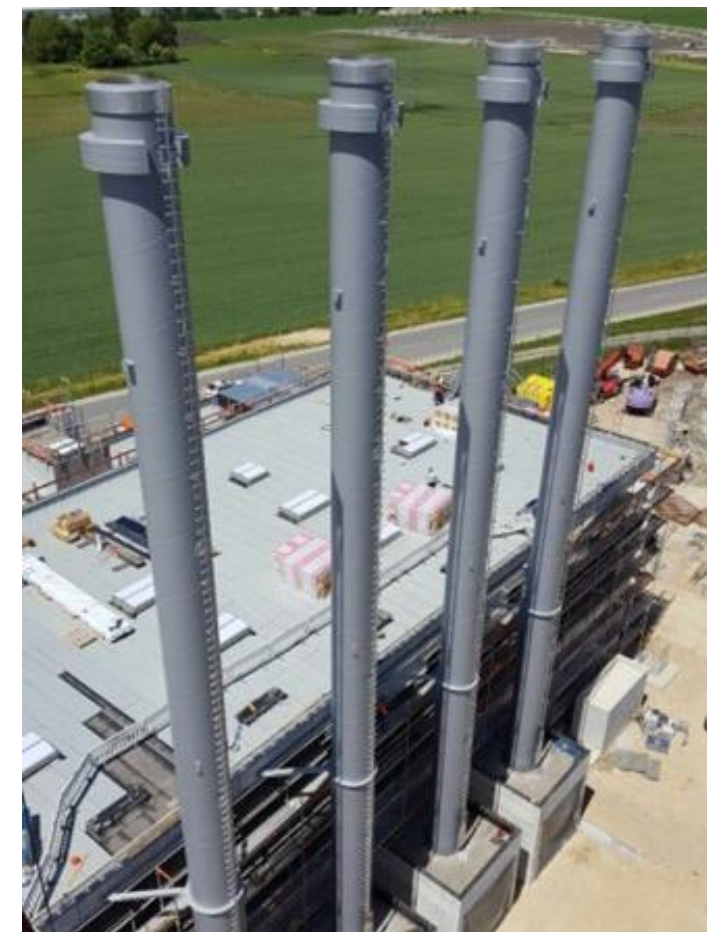

DC FRANKFURT

GERMANY

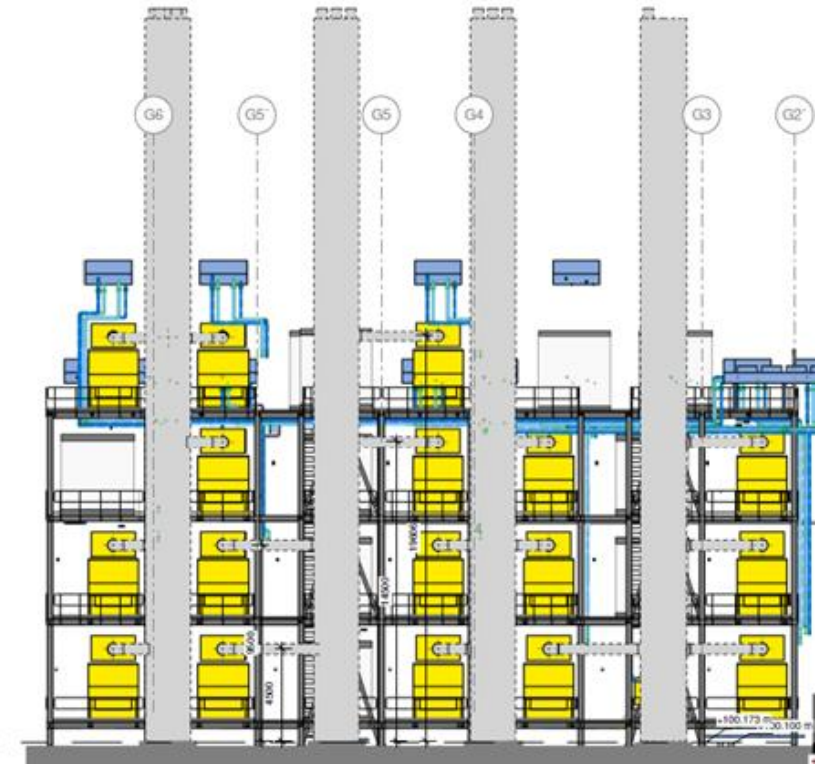

REFERENCIAS

PALAU SANT JORDI, BARCELONA
POLIDEPORTIVO BENTABERRI, SAN SEBASTIÁN
SOLDEU EL TARTER, ANDORRA
CENTRAL TÉRMICA FASA, VALLADOLID
COMPLEJO EDUCATIVO, PISA, ITALIA
PLANTA BIOMASA BURGOS
PLÁSTICOS MEXICHEM, ALTAMIRA MÉXICO
PLANTA QUÍMICA, BURGOS
BAYONA, FRANCIA
HOSTAL PREMIUM „POSHTEL“, BILBAO
PLANTA INDUSTRIAL, SONDRIO, ITALIA
FABRICA DE CACAO, TERRASSA
PHARMA MONZA
REFINERÍA DE ALUMINIO, LEGUTIANO
CHIESI PHARMA, PARMA, ITALIA
FABRICA NEUMÁTICOS, MILÁN, ITALIA
HOTEL SELENZA, MADRID
PANADERÍA INDUSTRIAL, FLUMERI ITALIA

RED DE CALEFACCIÓN URBANA
CENTRAL TÉRMICA
RED DE CALEFACCIÓN URBANA
INDUSTRIA AUTOMOCIÓN
RED DE CALEFACCIÓN URBANA
RED DE CALEFACCIÓN PARQUE INDUSTRIAL
CENTRAL ENERGÍA - TRIGENERACIÓN
PLANTA TRATAMIENTO DESULFURACIÓN
PLANTA TRATAMIENTO DE HUMOS
EXTRACCIÓN DE CAMPANAS CON RESISTENCIA AL FUEGO EI30
CALDERAS, INDUSTRIA ALIMENTARIA
HORNOS, INDUSTRIA ALIMENTARIA
INDUSTRIA FARMACÉUTICA
INDUSTRIA SIDERÚRGICA
INDUSTRIA FARMACÉUTICA
CENTRAL TÉRMICA
EXTRACCIÓN DE CAMPANAS CON RESISTENCIA AL FUEGO EI30
HORNO PANADERÍA INDUSTRIAL

JEREMIAS INDUSTRIAL EXHAUST SOLUTIONS

www.jeremias-group.com





¡GRACIAS POR SU ATENCIÓN!